



 ecoglo[®]
VISIBLY BETTER

A hand holding a flashlight is shown in the lower-left foreground, illuminating a staircase. The light from the flashlight creates a bright, conical beam that highlights the steps of the staircase, which recede into the distance. The overall scene is dark, with the flashlight providing the primary source of light, creating a dramatic and focused effect.

Innovation
Superior performance
Durability
Exceptional value

Kinesik Engineered Products Incorporated
www.kinesik.ca



ENGINEERED PRODUCTS

Kinesik Engineered Products Incorporated is a global leader of products that provide compliance to accessibility and life safety codes for the built environment. With over 40 years experience as a manufacturer, Kinesik’s leading research insights and progressive product development have lead to constant innovation and continuous improvement.

Our experience in building code compliance, from involvement in code councils to innovation with standards organizations has fueled our commitment to constantly improve our product offerings. We maximize efficiencies in manufacturing and global materials sourcing with an eye to enhanced engineering in order to deliver exceptional value.

Our product offerings of alternative methodologies are specialized for solving technical projects in scope and complexity as in our Armor Deck® Transit Platform Systems, Nexatherm® Snow and Ice Heated Solutions to as simple as Ecoglo® photoluminescent and contrast step edge. All of our products are supported with engineering service in-house and in the field, as well as, our highly skilled factory trained installation crews available for turnkey solutions or contractor support.

Our customers have come to trust Kinesik and our brands as the premiere name in built environment compliance products that help mitigate their risk and liability.

Our technical representatives are available across Canada to assist you in finding the best products and installation advice to solve your safety and accessibility code issues.

New innovations from Kinesik Engineered Products:



Proud members of:





Introducing the **visibility better** solution in life safety systems and risk management.

Ecoglo is a leading global innovator of UL certified photoluminescent egress markings, exit signs and emergency signage that exceed worldwide code requirements. Ecoglo has a reputation for innovative, durable products designed to work in the real world. Ecoglo products are manufactured using a patented process which produces fast-charging and long-lasting photoluminescent performance that is UV stable and highly durable.

Ecoglo photoluminescent products will enhance patron safety in venues helping to prevent trips, slips and falls in all light conditions. *Remember... with Ecoglo, you'll never miss a step!*

How the Ecoglo System Works

Ecoglo uses a patented process to produce a range of products that provide a four pronged solution to pathfinding needs:

Step edge contrast
Slip-resistance

Visibility in all light conditions
Resistance to wear

Rough

The hard wearing silicon carbide non-slip material is just what you need to reduce slips and falls in all weather conditions. Your patrons will commend you, not complain to you. With their UV resistance and good looks, you can confidently install Ecoglo products inside and out.

Tough

Our patented process bakes in the photoluminescent powder and non-slip material and you get to savor the results. Thousands of people can walk on these products thousands of times with no wear and tear. And just to make sure, we've put them through extensive testing at internationally accredited laboratories relating to durability, weather resistance, UV resistance, stain resistance, abrasion and cleaning. And they passed with flying colours.

Seen

Unlike electrical or battery lighting, Ecoglo products will never let you down. They will glow brightly in the dark for many hours giving your patrons confidence in exiting, even in an emergency. Some steps are just too hard to see, whether it be day or night. With Ecoglo, you can be sure your patrons will see the steps, not fall down them, whatever the light conditions. It's the combination of the photoluminescent strip and the non-slip material that creates such great step edge definition.

Green

Every small step you take to reduce electricity usage helps save our environment. Ecoglo products let you recycle natural sunlight or artificial light. No electricity is required. Ecoglo also goes green by using recycled aluminum. All products are non-toxic and non-radioactive. Designed to last the life of your facility, Ecoglo avoids maintenance costs. Ultimately, Ecoglo is recyclable which avoids the cost of landfill dumping.

How to specify Ecoglo products

Ecoglo provides several design file formats for its products in order to make the job of specifying easier than ever. From step edge contrasts, stair nosings, pathway marking, egress signs, and more, you now have more choices when specifying Ecoglo products for your next project.

Whether you need 2D CAD drawings, 3-part specifications, brochures, videos, installation instructions, and now BIM (Revit) objects, Ecoglo has you covered.



Ecoglo Technical Advantage



ENGINEERED PRODUCTS

The Ecoglo Photoluminescent (PL) range of products provide significant benefit during low light conditions and emergency blackout situations. With a proven track record in reducing slips and falls Ecoglo products provide improved health and safety with additional benefits in any smoke hazard situation.

Used for way-marking, step nosings and signage, the products are UV stable and highly durable, lasting for many years. The products are easily installed and have minimal maintenance costs.

Comparative Advantage

ECOGLO

Luminance

Ecoglo products are manufactured using a patented process that is only used by Ecoglo. This tightly controlled application embeds the photoluminescent particles in a clear durable polymer.

The physical nature of the dry powder embedding process and the optical properties of the polymer ensure maximum efficiency of the photoluminescent particles to absorb useful wavelengths from a natural or artificial light source. This light then re-emits from the product towards a viewer's eye.

Ecoglo products use a custom produced photoluminescent pigment which has greater longevity of glow than all the other pigments (over 100) which Ecoglo has sampled since 2001.

Ecoglo uses dry powder for maximum luminance.

Visibility

All Ecoglo products are engineered to provide greater visibility than relevant codes and standards currently require. Photoluminescent visibility is affected by more than just brightness ('Luminance'); the other factor is contrast against adjacent surfaces.

Contrast against adjacent surfaces is the critical parameter for visibility on a step edge. Ecoglo step-edge products incorporate a black anti-slip strip that provides excellent luminance contrast and colour contrast to the PL strip, so the step edge is clearly defined in all lighting conditions: dark conditions, light conditions and twilight or dim conditions.

This means the Ecoglo products are visible from a greater distance and for a longer time after the lights go out. Ecoglo incorporates a black anti-slip strip for maximum visibility and edge contrast.

NON - ECOGLO

A widely used alternative manufacturing process uses liquid formulations that carry the photoluminescent particles.

Liquid formulations can suffer from settling out of the dense photoluminescent particles resulting in inconsistent luminance properties.

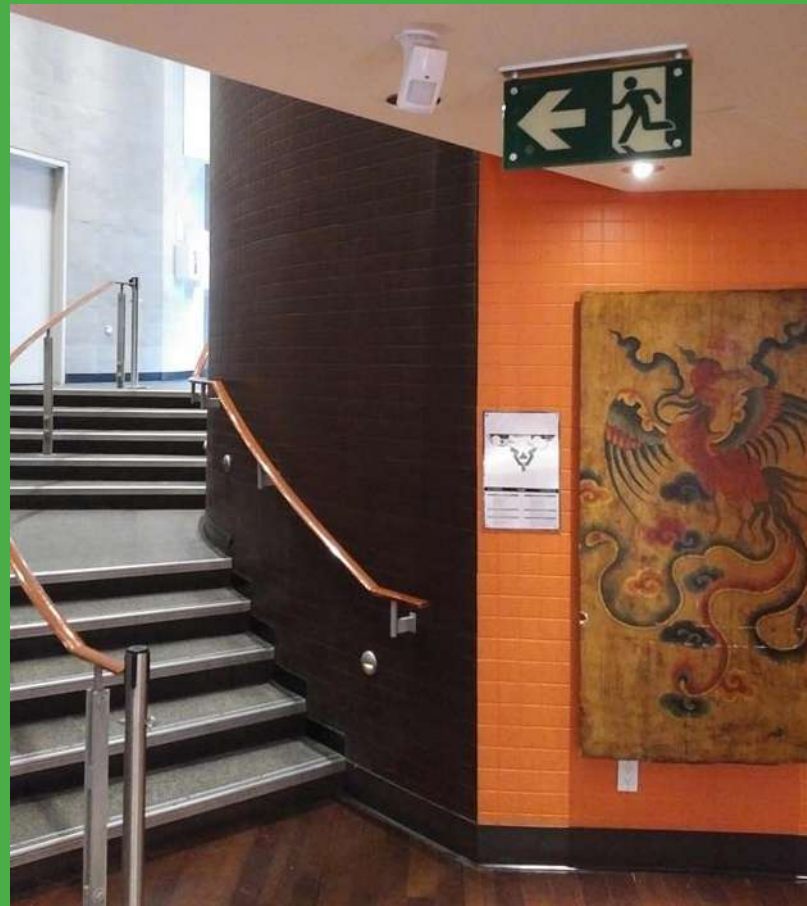

Ecoglo Technical Advantage

ECOGLO

Durability of Photoluminescence

The Ecoglo range has been subjected to accelerated UV/weathering exposure and proven to be highly resistant to the effects of UV/weathering.

Testing has been extended from the usual 1000 hour or 2000 hour test, out to 6000 hours, which can be interpreted to be similar to around 30 years of outdoor exposure.

At 6000 hours exposure, while there is noticeable loss of gloss of the top surface, the loss in PL brightness is less than can be detected by the human eye (measured reduction of 5-8%).

The unique ridges in the photoluminescent strips protect the glowing areas from most abrasive wear, and other incidental abuse.

Ecoglo uses its patented process for maximum durability. Using powder means the polymer we use is "long chain" which forms a strong UV resistant product when bonding.

Installed Durability

The manufacture of all Ecoglo products involves the integral bonding of the photoluminescent layer to a rigid aluminum substrate, so there is no chance of delamination or peeling. Rigid products spread any applied loads over a greater area of installation adhesive.

Ecoglo signage uniquely incorporates an integrally bonded anti-graffiti protective top coat over the print, which also protects the print from abrasive wear. Because this top layer bonds into the substrate, there is no chance of delamination or peeling.

Ecoglo bonds onto rigid aluminum and applies a protective top coat for greater installed durability.

Slip Resistance

The unique ridges in the Ecoglo photoluminescent strips and the integrated anti-slip contrast strips provide all-weather slip resistance.

Ecoglo combines ridges and anti-slip contrast strips for slip resistance.



Ecoglo Product Range Includes

Stair nosings	Step edge contrast strips
Pathmarking guidance strips	Hazard strips
Handrail guidance strips	Directional signage
Floor identification markers	Seat and aisle markers

Ecoglo vs. Traditional Emergency Lighting Backup Systems

Comparative Advantage

ECOGLO

Effectiveness

- The energy stored in Ecoglo photoluminescent pigments will continuously exhaust for over 100 hours until it needs to be recharged by re-exposing it to a light source
- With PL way-finding systems, an image of the pathway is created by outlining elements such as steps, landings, doors, etc. and critical information such as change in floor level or direction
- PL way-finding systems can play a vital life-saving role by showing the safe exit path, even in heavy smoke
- The standard when designing PL way-finding systems for smoky conditions is low-level continuous marking less than 1 meter above the floor level
- Even if in a dark room for a week, it can recharge for a 2 hour evacuation in as little as 10 minutes

Installation

- Installation can be completed by any competent handyman

Maintenance

- Occasional dusting

Life Span

- 35 year life-span

Environmental Impact

- Ecoglo is not radioactive or toxic and uses no energy. In 35 years, the aluminum can be recycled

NON - ECOGLO

Effectiveness

- Experience problems with partial or total failure
- Limited operating time
- Cast insufficient light
- High mounted emergency lights can easily be totally extinguished when there is smoke in the air
- Location of high light casts shadows
- Every model requires a battery or generator system that could provide electricity to the lights during a blackout
- If completely drained an emergency backup battery can take up to 7 days to recharge

Installation

- Requires costly installation by electricians

Maintenance

- Annual inspection and regular replacement of bulbs, batteries, or generators

Life Span

- 2-7 year life-span

Environmental Impact

- Emergency lights are not recyclable and over 35 years, up to 7 systems will need to be installed



Electrical light casts shadows on steps and slows evacuation

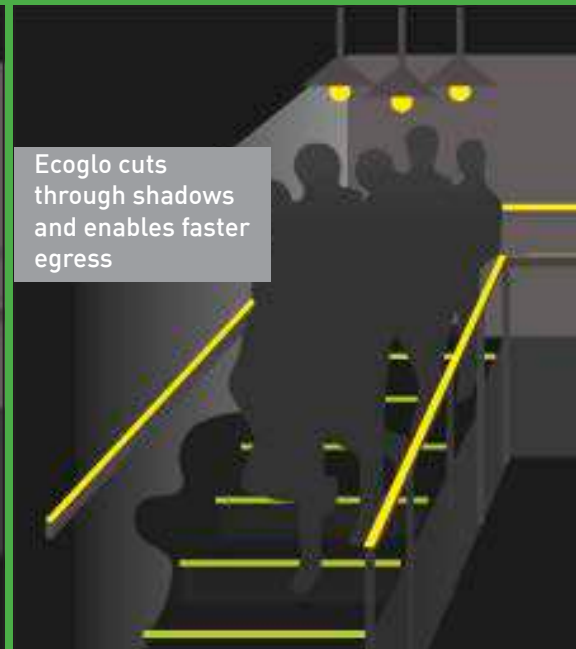

Ecoglo cuts through shadows and enables faster egress

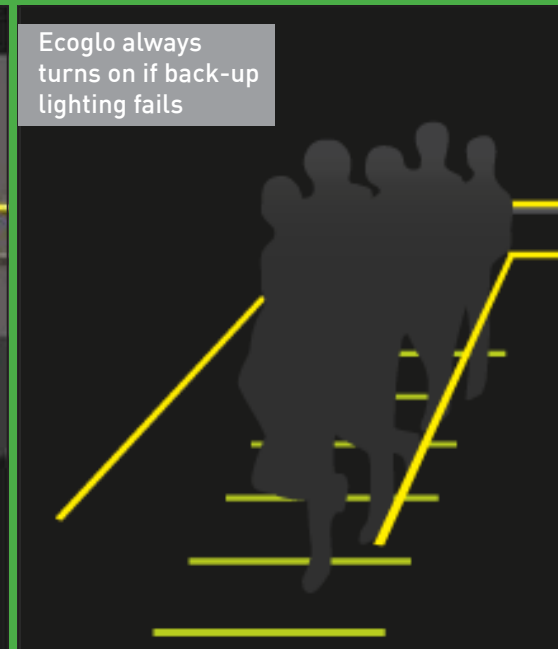

Ecoglo always turns on if back-up lighting fails

Luminous Egress Path Markings Compliance Guide

ULC S590

1025.1 General

Approved luminous egress path markings delineating the exit path shall be provided in high-rise buildings of Group A, B, E, I, M, and R-1 occupancies in accordance with Sections 1025.1 through 1025.5.

Exception: Luminous egress path markings shall not be required on the level of exit discharge in lobbies that serve as part of the exit path in accordance with Section 1028.1, Exception 1.

Applicable Occupancy Groups:

- A Assembly
- B Business
- E Educational
- R1 Transient Residential
- I Institution
- M Mercantile

1025.2 Markings within Exit Components

Egress path markings shall be provided in interior exit stairways, interior exit ramps and exit passageways, in accordance with Sections 1025.2.1 through 1025.2.6.

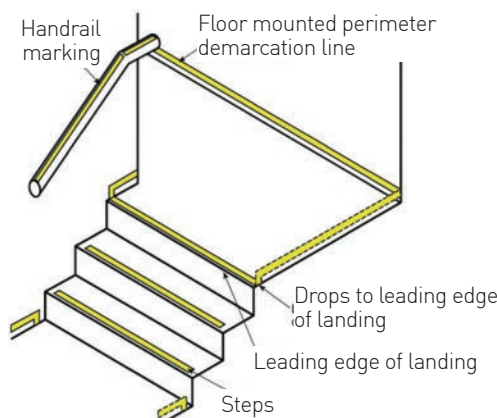
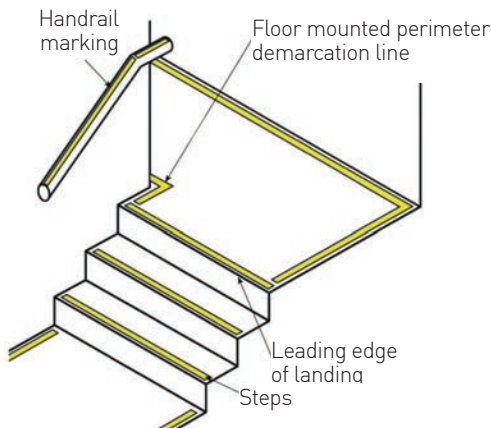

1025.2.1 Steps

A solid and continuous stripe shall be applied to the horizontal leading edge of each step and shall extend for the full length of the step. Outlining stripes shall have a minimum horizontal width of 1 inch (25 mm) and a maximum width of 2 inches (51 mm). The leading edge of the stripe shall be placed not more than 1/2 inch (12.7 mm) from the leading edge of the step and the stripe shall not overlap the leading edge of the step by not more than 1/2 inch (12.7 mm) down the vertical face of the step.

Exception: The minimum width of 1 inch (25 mm) shall not apply to outlining stripes listed in accordance with UL 1994.

Steps and Landing Products

E Series: Photoluminescent contrast strips

F / RF Series: Flat aluminum stair nosings with photoluminescent contrast strips

S Series: Cast-in-place aluminum stair nosings with photoluminescent contrast strips

G3001 / G6001: Photoluminescent guidance strip

1025.2.2 Landings

The leading edge of landings shall be marked with a stripe consistent with the dimensional requirements for steps.

1025.2.3 Handrails

All handrails and handrail extensions shall be marked with a solid and continuous stripe having a minimum width of 1 inch (25 mm). The stripe shall be placed on the top surface of the handrail for the entire length of the handrail, including extensions and newel post caps. Where handrails or handrail extensions bend or turn corners, the stripe shall not have a gap of more than 4 inches (102 mm).

Exception: The minimum width of 1 inch (25 mm) shall not apply to outlining stripes listed in accordance with UL 1994.

Handrail Products

H3001 / H5001: Handrail strip end caps

G3001 / G6001: Photoluminescent guidance strip

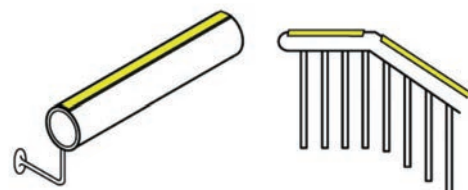

Luminous Egress Path Markings Compliance Guide

Under 2015 IFC/IBC 1025 | 2009-2012 Section 1024

1025.2.4 Perimeter Demarcation Lines

Stair landings and other floor areas within interior exit stairways, interior exit ramps and exit passageways, with the exception of the sides of steps, shall be provided with solid and continuous demarcation lines on the floor or on the walls or a combination of both. The stripes shall be 1 to 2 inches (25 mm to 51 mm) wide with interruptions not exceeding 4 inches (102 mm).

Exception: The minimum width of 1 inch (25 mm) shall not apply to outlining stripes listed in accordance with UL 1994.

Perimeter Demarcation Line Products

T5-G3001 / T8-6001:	Aluminum track and photoluminescent guidance strip
G3001 / G6001:	Photoluminescent guidance strip

1025.2.4.2.1 Wall-mounted Demarcation Lines

Perimeter demarcation lines shall be placed within 4 inches (102 mm) of the wall and shall extend to within 2 inches (51 mm) of the markings on the leading edge of landings. The demarcation lines shall continue across the floor in front of all doors.

Exception: Demarcation lines shall not extend in front of exit discharge doors that lead out of an exit and through which occupants must travel to complete the exit path.

1025.2.4.2.2 Wall-mounted Demarcation Lines

Perimeter demarcation lines shall be placed on the wall with the bottom edge of the stripe not more than 4 inches (102 mm) above the finished floor. At the top or bottom of the stairs, demarcation lines shall drop vertically to the floor within 2 inches (51 mm) of the step or landing edge. Demarcation lines on walls shall transition vertically to the floor and then extend across the floor where a line on the floor is the only practical method of outlining the path. Where the wall line is broken by a door, demarcation lines on walls shall continue across the face of the door or transition to the floor and extend across the floor in front of such door.

Exception: Demarcation lines shall not extend in front of exit discharge doors that lead out of an exit and through which occupants must travel to complete the exit path.

1025.2.4.3 Transition

Where a wall-mounted demarcation line transitions to a floor-mounted demarcation line, or vice-versa, the wall-mounted demarcation line shall drop vertically to the floor to meet a complimentary extension of the floor-mounted demarcation line, thus forming a continuous marking.

1025.2.5 Obstacles

Obstacles at or below 6 feet 6 inches (1981 mm) in height and projecting more than 4 inches (102 mm) into the egress path shall be outlined with markings not less than 1 inch (25 mm) in width comprised of a pattern of alternating equal bands, of luminous material and black, with the alternating bands not more than 2 inches (51 mm) thick and angled at 45 degrees (0.79 rad). Obstacles shall include, but are not limited to, standpipes, hose cabinets, wall projections, and restricted height areas. However, such markings shall not conceal any required information or indicators including but not limited to instructions to occupants for the use of standpipes.

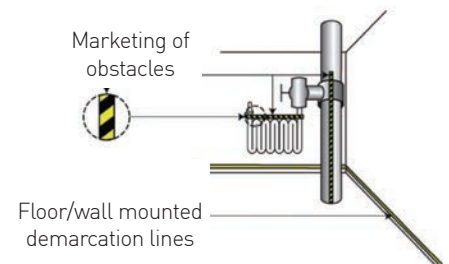

Floor/wall mounted demarcation lines

Obstacles

OB20025:	Photoluminescent obstruction strip
G250R-OB:	Photoluminescent obstruction strip
G250R-OB-C:	Photoluminescent obstruction strip - Curved
G300F-OB:	Photoluminescent obstruction tape

1025.2.6 Doors within the Exit Path

Doors through which occupants must pass in order to complete the exit path shall be provided with markings complying with Sections 1025.2.6.1 through 1025.2.6.3.

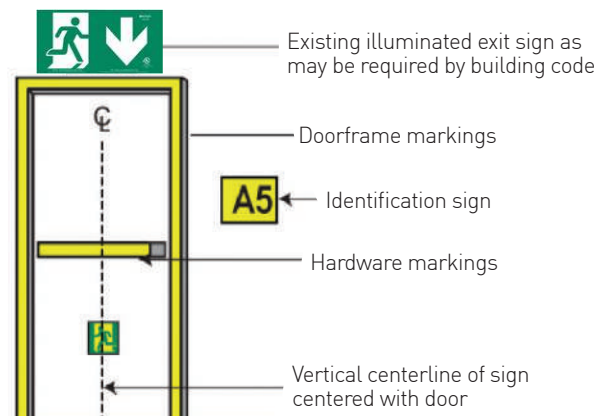

Luminous Egress Path Markings Compliance Guide

Under 2015 IFC/IBC 1025 | 2009-2012 Section 1024

1025.2.6.1 Emergency Exit Symbol

The doors shall be identified by a low-location luminous emergency exit symbol complying with NFPA 170. The exit symbol shall be not less than 4 inches (102 mm) in height and shall be mounted on the door, centered horizontally, with the top of the symbol not higher than 18 inches (457 mm) above the finished floor.

Emergency Exit Symbol	
R Series:	Running man photoluminescent directional and door exit signs

1025.2.6.2 Door Hardware Markings

Door hardware shall be marked with not less than 16 square inches (406 mm²) of luminous material. This marking shall be located behind, immediately adjacent to, or on the door handle or escutcheon. Where a panic bar is installed, such material shall be not less than 1 inch (25 mm) wide for the entire length of the actuating bar or touchpad.

Door Hardware Markings	
DHM Series:	Door hardware indicators

1025.2.6.3 Door Frame Markings

The top and sides of the door frame shall be marked with a solid and continuous 1-inch- to 2-inch-wide (25 mm to 51 mm) stripe. Where the door molding does not provide sufficient flat surface on which to locate the stripe, the stripe shall be permitted to be located on the wall surrounding the frame.

Door Frame Markings	
G3001 / G6001:	Photoluminescent guidance strip
T5-G3001 / T8-6001:	Aluminum track and photoluminescent guidance strip
T11-G300:	Aluminum track and photoluminescent guidance strip

1025.3 Uniformity

Placement and dimensions of markings shall be consistent and uniform throughout the same enclosure.



About the Accessibility for Ontarians with Disabilities Act

The Accessibility for Ontarians with Disabilities Act, 2005 (AODA) became law on June 13, 2005. The purpose of the AODA is to benefit all Ontarians by developing, implementing and enforcing accessibility standards. The goal is to achieve accessibility for Ontarians with disabilities with respect to goods, services, facilities, accommodation, employment, buildings, structures and premises by January 1, 2025. On December 27, 2013, Ontario Regulation 368/13 was filed to amend the new 2012 Building Code, O.Reg. 332/12. The effective date of the amendment is January 1, 2015.

AODA Standards For Stairs Treads and Risers

A flight of stairs shall have a horizontal strip at the edge of the tread that

1. 50 ± 10 mm deep
2. Is colour-contrasted with the tread and riser
3. Extends the full width of the tread
4. Is slip-resistant

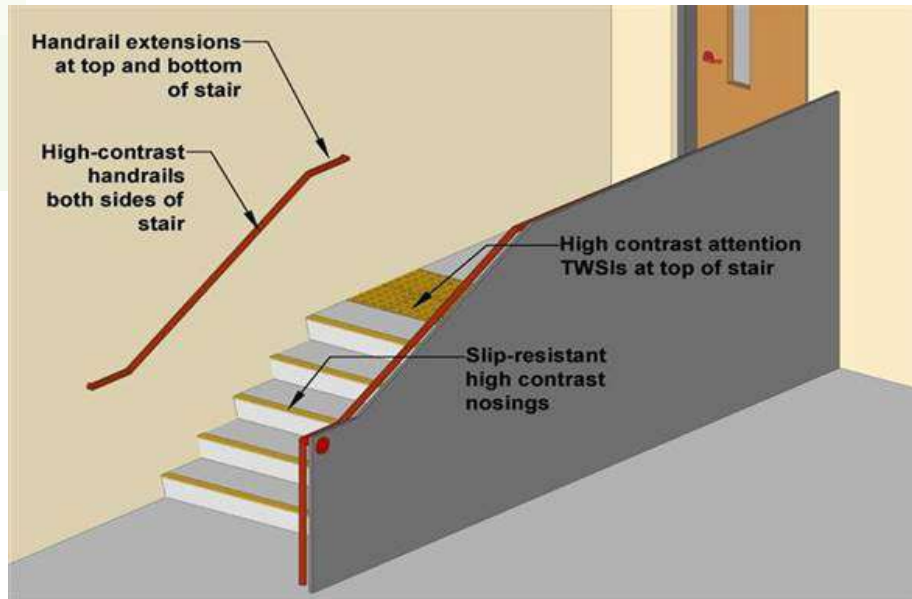

System Design

Where to install Ecoglo in Arenas

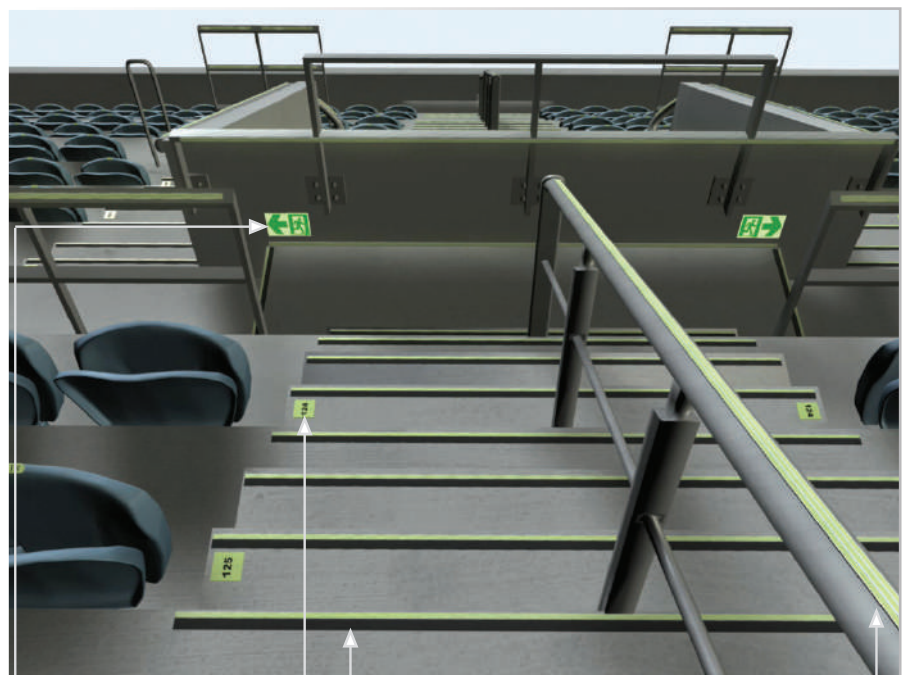
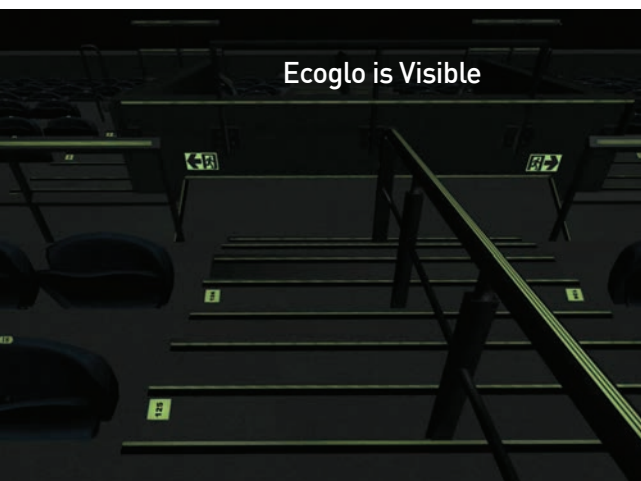

System Design

Where to install Ecoglo in Theatres



Handrail Strips

Aisle Markers

Seat Numbers

Step Edging

Where to install Ecoglo in Fire Exit Stairways

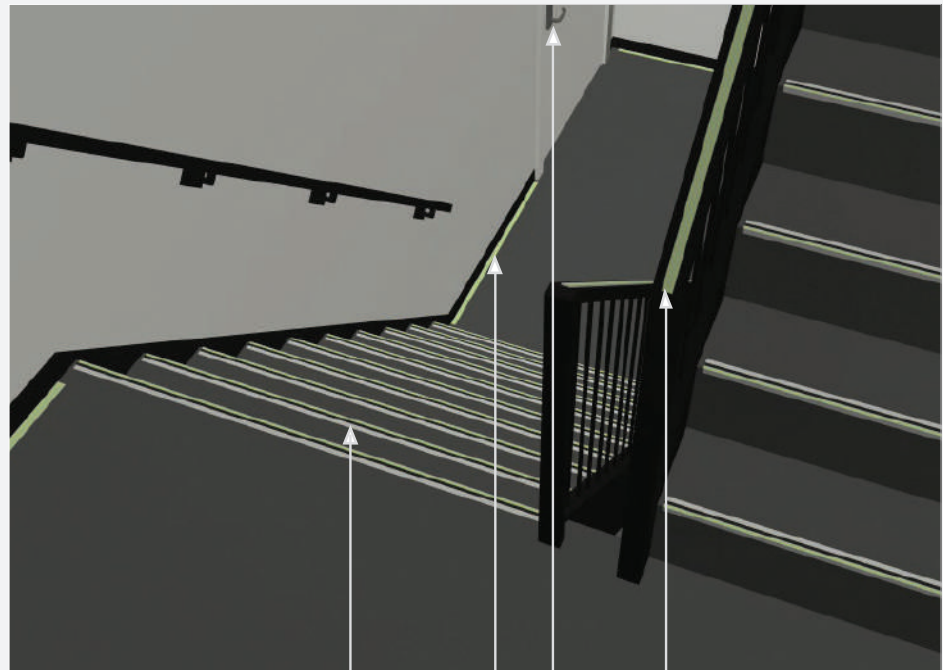

Step Edging

Demarcation Strip

Exit Sign (Above Door)

Handrail Strips

Luminance Requirements

Around the world standards for PLM pathmarking have increased performance requirements over the years. Today Canada has the highest standard for PLM performance. Ecoglo Pathmarking products meet the tough Canadian standards and exceed all others.

ULC S572 in Canada

ULC S572 is the standard stipulated in the national building code and has been adopted by all provincial building codes. Photoluminescent material used in signs and pathmarking in Canada must be certified as performing at this standard. Each element must be seen at the required distance after two hours.

ULC S572 Standard for the Installation use of Safety, Way Guidance Systems Proposed Canadian Standard

ULC S590 is a standard that provides requirements for floor proximity and other egress path marking and lighting systems that provide a visual delineation of the path of egress. These systems are also used to identify significant egress path features such as doors, stair banisters, obstacles or information placards.

Such systems are intended for installation and use as required by building and fire safety codes around the world such as the Life Safety Code, NFPA 101; the Building Construction and Safety Code, NFPA 5000, and the International Building Code sponsored by the International Code Council. ULC S590 is the standard the Canadian National Blind Counsel will refer to.

ULC S572 requires each system element to be recognizable from a distance of 25 feet, and also requires all elements that may be applied to a floor or step to meet UL410 Slip Resistance of Floor Surface Materials, and to be tested for the effects of cleaning.

This means the Ecoglo products are visible from a greater distance and for a longer time after the lights go out. Ecoglo incorporates a black anti-slip strip for maximum visibility and edge contrast.

ISO, CSA, AODA, CANADIAN ACCESSIBILITY

Complies with provincial and federal guidelines

- [ISO 23599: 2012](#)
- [CSA B651-12](#)
- [Integrated Accessibility Standards Regulation 191/11 \[Sections 80.25 through 80.29\]](#)
- [Ministry of Municipal Affairs and Housing \(Ontario Building Code\) New Accessibility Amendments to Ontario's Building Code](#)
- [Overview of Updated Accessibility Requirements](#)

For full industry standards visit: www.kinesik.ca

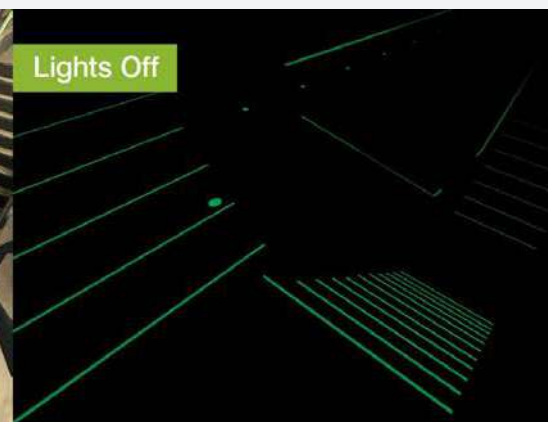

Charging Tables

Fluorescent Charging of Ecoglo Pathmarking Material

150 LUX, 4000K in a Reasonably Lit Area	
Activation Time	Hours of Visibility
5 minutes	2.50 hours
10 minutes	4.00 hours
20 minutes	6.00 hours
30 minutes	7.00 hours

20 LUX, 4000K in a Poorly Lit Area	
Activation Time	Hours of Visibility
5 minutes	0.50 hours
10 minutes	1.00 hours
20 minutes	2.25 hours
30 minutes	3.00 hours

300 LUX, 4000K in a Well Lit Area	
Activation Time	Hours of Visibility
5 minutes	4.00 hours
10 minutes	6.00 hours
20 minutes	7.00 hours
30 minutes	8.00 hours

Ecoglo Brightness Decay Curve

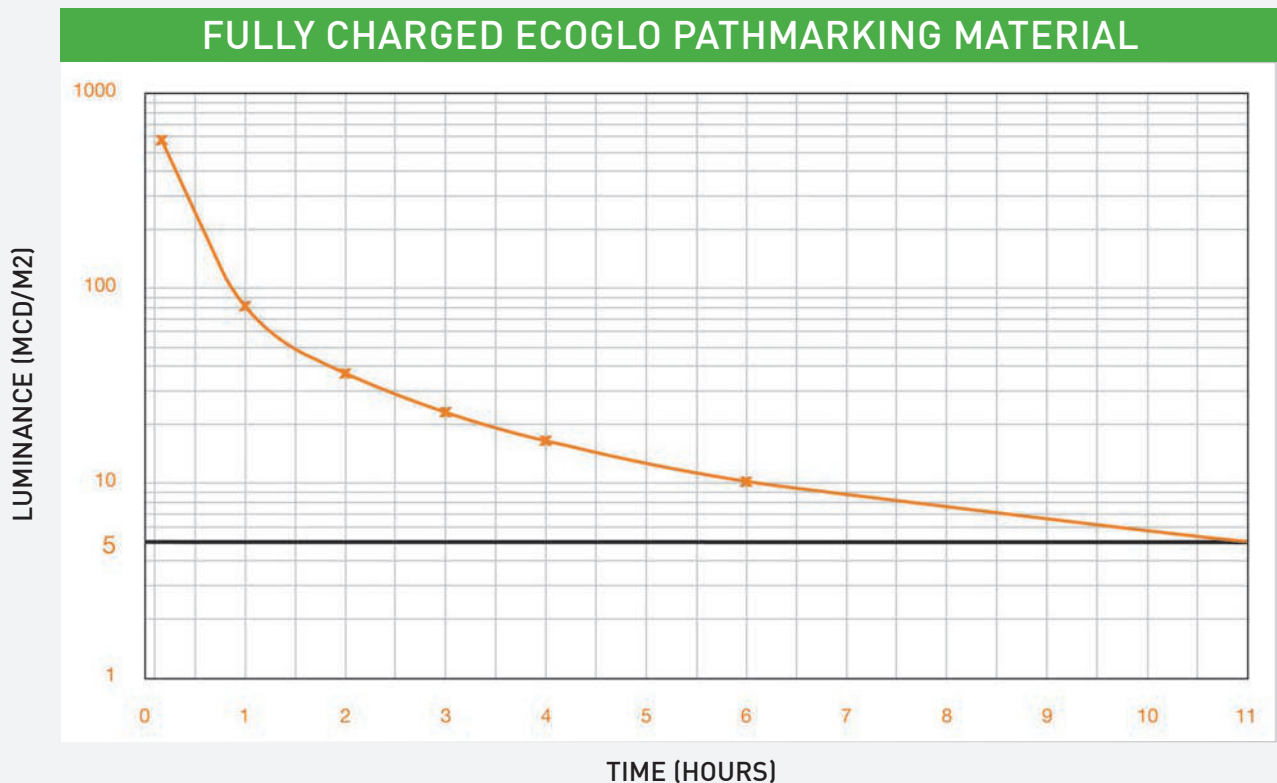

Durability Standards and Tests

Benefits and Technical Details

Ecoglo products meet or exceed the performance criteria specified in the following tests or standards:

- In Canada, ULC S572
- In United States, UL924

1. High Visibility In Dark or Light Conditions

Brightness:

- ASTM E2073, Standard Test Method for Photopic Luminance of Photoluminescent (Phosphorescent) Markings.
- DIN 67510 Part 1, Phosphorescent Pigments and Products: Measurement and identification by the manufacturer.
- ISO 17398:2004 Clause 7.11, Safety Colours and Safety Signs - Classification, Performance and Durability of Safety Signs.

2. High Durability Indoors and Outdoors

UV Stability:

- ASTM G155-04 Cycle 1 2000hrs, Standard Practice for Operating Xenon Arc Light Apparatus for Exposure of Non-metallic Materials.
- Salt Spray Resistance: ASTM B117-97 500hrs, Standard Practice for Operating Salt Spray (Fog) Apparatus.
- Freeze-Thaw Resistance: ASTM C1026-87(1996), Standard Test Method for Measuring the Resistance of Ceramic Tile to Freeze-Thaw Cycling.

3. Reduces Slips

Slip Resistance:

- UL410, Standard for Slip Resistance for Floor Surface Materials.
- AS/NZS 4586-1999, Slip Resistance Classification of New Pedestrian Surface Materials.
- AS/NZ 4586 - 2004, Slip resistance classification of new pedestrian surface materials-App. D (oil- wet ramp test).

4. Head Wearing

Abrasion Resistance:

- ASTM D1242-95a, Standard Test Methods for Resistance of Plastic Materials to Abrasion.
- ASTM B 244-97, Test Methods for Measurement of Anodic Coatings on Aluminum and other Nonconductive Coatings on Nonmagnetic Basis Metals with Eddy-Current Instruments.
- ASTM B137-95(2000), Test Method for Measurement of Coating Mass per Unit Area of Anodically Coated Aluminum.
- ASTM F510-93(2004), Standard Test Method for Resistance to Abrasion of Resilient Floor Coverings Using an Abrader with a Grit Feed Method.
- JIS H8682-1:1999, Test Methods for Abrasion Resistance of Anodic Oxide Coatings on Aluminium and Aluminium Alloys- Wheel Wear Test.

5. Easy Cleaning

Washability:

- ASTM D4828-94(2003), Standard Test Methods for Practical Washability of Organic Coatings.
- ASTM B136-84(1998), Standard Test Method for Measurement of Stain Resistance of Anodic Coatings on Aluminum.

6. No Radioactivity or Toxicity

Radioactivity:

- ASTM D3648-2004, Standard Practices for the Measurement of Radioactivity.
- Toxicity: Bombardier SMP 800-C (2000), Toxic Gas Generation Test.

7. Does Not Burn

Flammability:

- ASTM E162-02, Standard Test Method for Surface Flammability of Materials Using a Radiant Heat Energy Source.
- ASTM D635-03, Standard Test Method for Rate of Burning and/or Extent and Time of Burning of Plastics in a Horizontal Position.
- FAA AC 23.2 Paragraph 4.b, Horizontal Burn Test.

Cleaning and Maintenance

Cleaning

Regular cleaning to remove built up dirt and objects on the strips will ensure Ecoglo will continue performing to expectation. Note that the photoluminescence will continue performing even after UV exposure or exposure to moisture. Vacuuming or brushing with a stiff bristle head (wet or dry) is often enough to keep the strips clean. The glowing strip can also be wiped clean with a wet or dry sponge or cloth. Observation will determine if cleaning is required, however a regular cleaning every 4 to 6 weeks or after particularly heavy use should ensure correct performance.

1. High-pressure water (but not steam cleaning) can also be used to clean the strips.
2. Do not use highly alkaline or acidic cleaning agents. The pH of the cleaning agents should be between pH 5 and pH 12. If cleaning agents are applied at more than pH 10, the strips should be rinsed with pH neutral (pH 6 to pH 8) solution afterwards.

Maintenance

Ecoglo products should be checked annually to ensure the following:

- All products are still in place as at installation and there is no material damage to any of these products.
- All products are clean from general dust build up and any other specific obscuring deposits such as gum or tar.
- All products are clearly visible and have not been covered by carpet or other materials.
- All products mark a clear path and have not been obstructed by physical hazards such as trolleys, machinery etc.
- All products can be used to provide clear escape path marking and there has been no change to the configuration of the building which renders them unusable.
- All light required to charge Ecoglo products is operating as designed at installation.

Step Edge Contrast Strips, Non-Slip Strips and Guidance Strips

E Series Contrast Strips - Photoluminescent Leading Edge



E2071

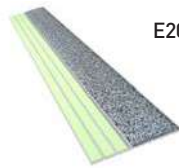

E2061

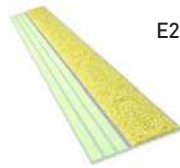

E2051

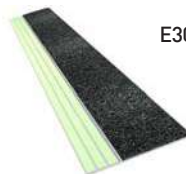
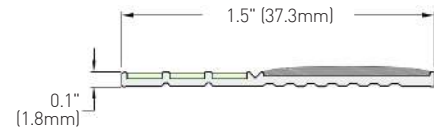

E3071



E3061

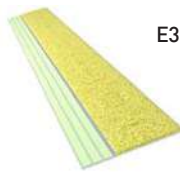

E3051

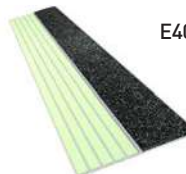
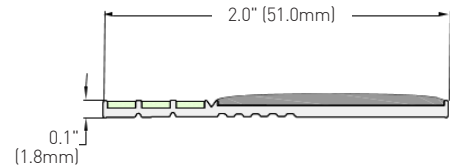

E4071



E4061

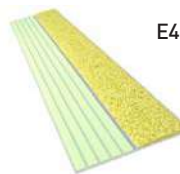

E4051

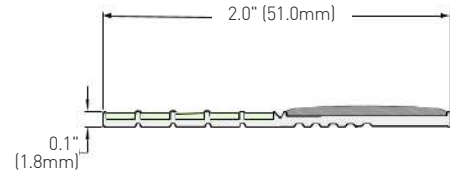

N Series Non-Slip Strips - Not Photoluminescent

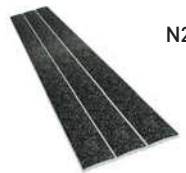

N2070



N2060



N2050

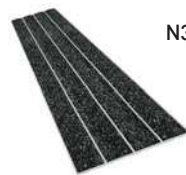
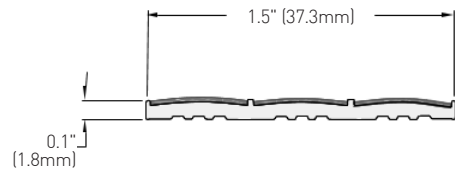

N3070



N3060



N3050

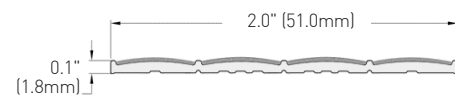

G Series Guidance Strips - Photoluminescent

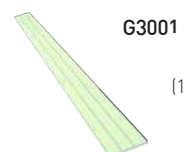

G3001

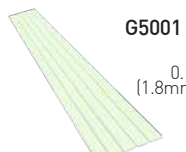
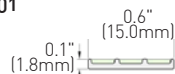

G5001

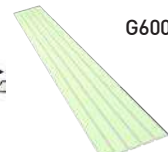

G6001





Contrast Strips, Handrail Strips and Guidance Strips

H Series Handrail Strips - Photoluminescent

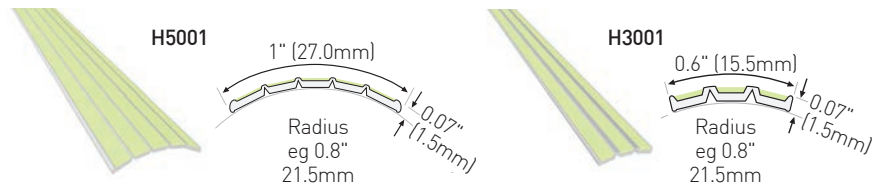

Handrail End Caps - Non Photoluminescent

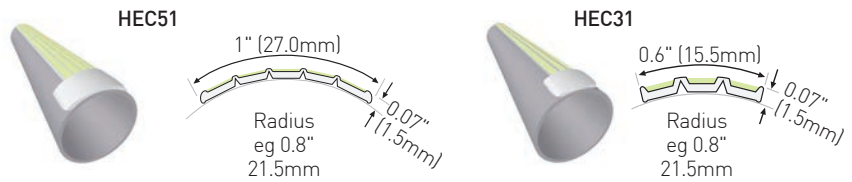

Photoluminescent Aluminum and Door Frame Rails

T Series Guidance Strips

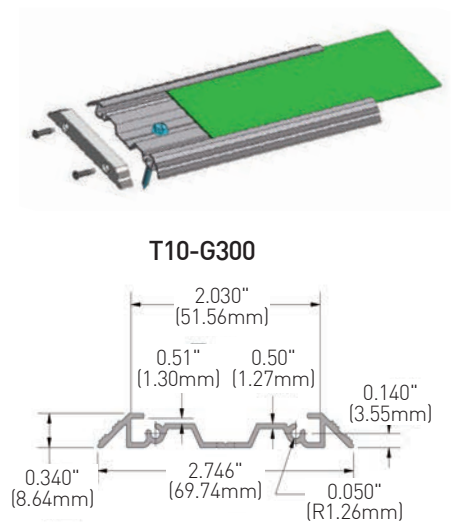
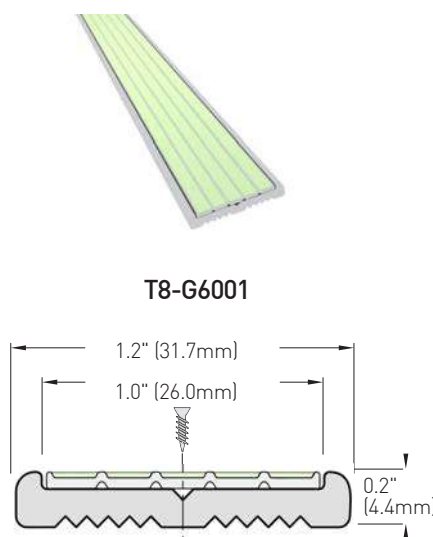
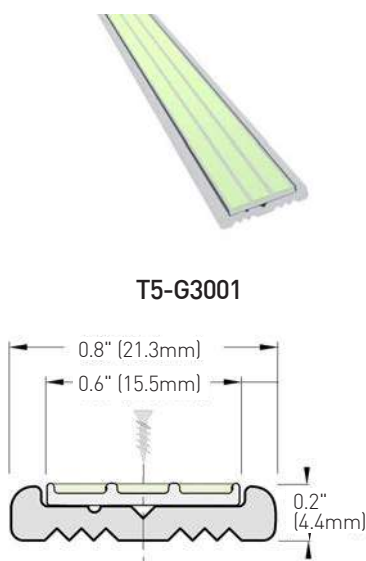

Photoluminescent Aluminum Door Frame Rails

T Series Door Frame Rails

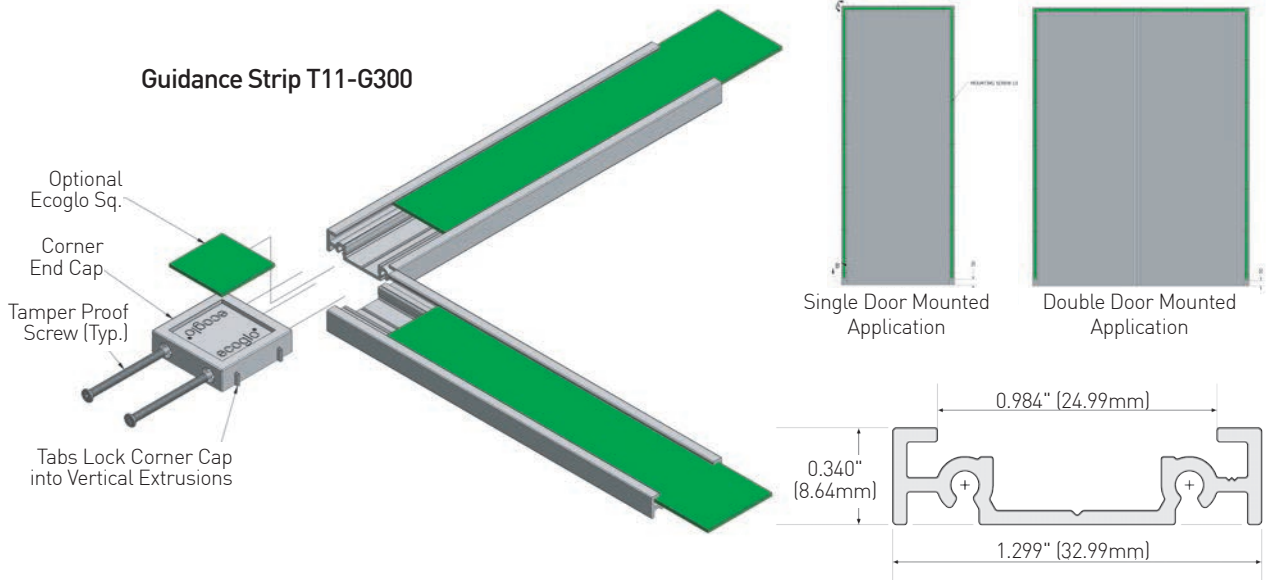

Stair Nosings

F Series Flat Stair Nosings

Clear and black anodized aluminum standard (Type 11, Class 1), bronze and custom colour anodizing available as a special order.



F4171
BLACK NON-SLIP



F4161
GREY NON-SLIP



F4151
YELLOW NON-SLIP

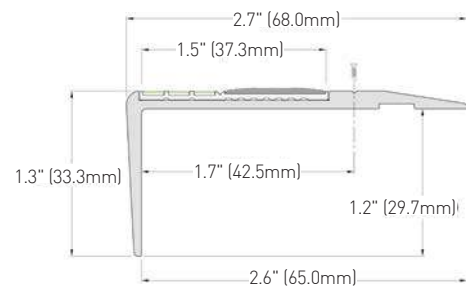

F4170
BLACK NON-SLIP



F4160
GREY NON-SLIP



F4150
YELLOW NON-SLIP

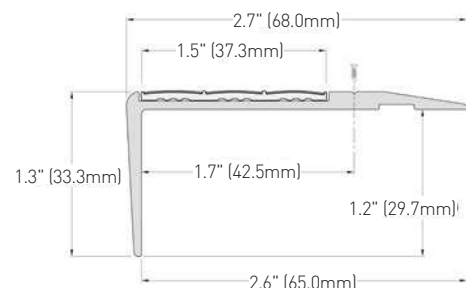

F Series Flat Stair Nosings

Clear anodized aluminum standard (Type 11, Class 1), black, bronze and custom colour anodizing available as a special order. Continued.

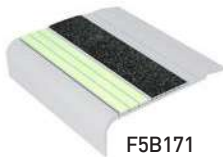

F5B171
BLACK NON-SLIP

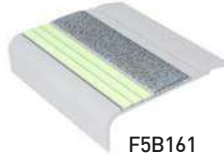

F5B161
GREY NON-SLIP

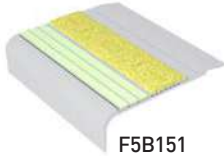

F5B151
YELLOW NON-SLIP

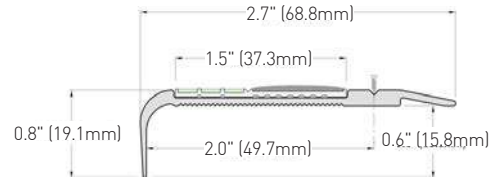

F5B170
BLACK NON-SLIP



F5B160
GREY NON-SLIP

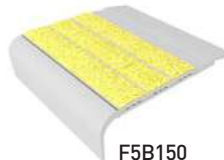

F5B150
YELLOW NON-SLIP

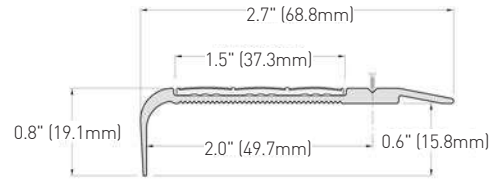

F6171
BLACK NON-SLIP



F6161
GREY NON-SLIP

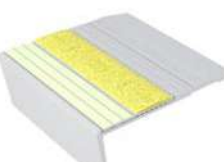

F6151
YELLOW NON-SLIP

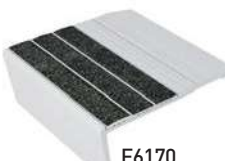
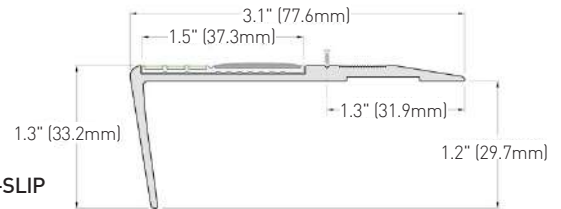

F6170
BLACK NON-SLIP



F6160
GREY NON-SLIP

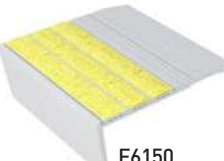

F6150
YELLOW NON-SLIP

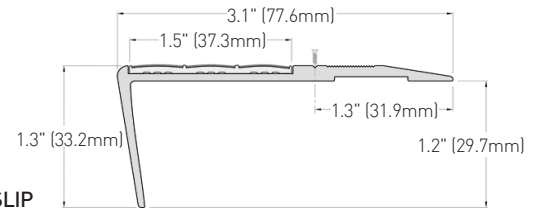

F7171
BLACK NON-SLIP



F7161
GREY NON-SLIP



F7151
YELLOW NON-SLIP

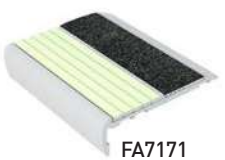
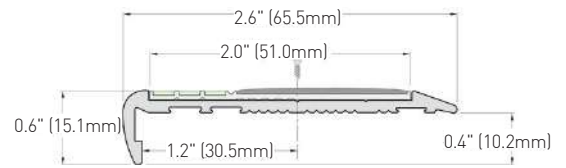

FA7171
BLACK NON-SLIP



FA7161
GREY NON-SLIP



FA7151
YELLOW NON-SLIP

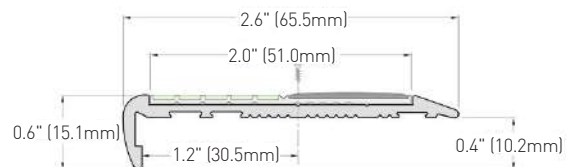

F Series Flat Stair Nosings

Clear anodized aluminum standard (Type 11, Class 1), black, bronze and custom colour anodizing available as a special order. Continued.

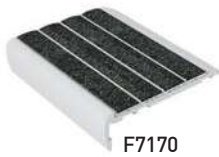

F7170
BLACK NON-SLIP



F7160
GREY NON-SLIP



F7150
YELLOW NON-SLIP

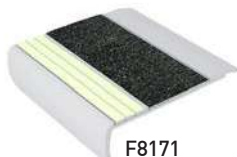
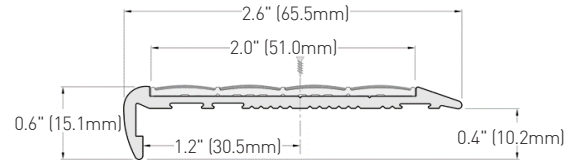

FA8171
BLACK NON-SLIP



FA8161
GREY NON-SLIP

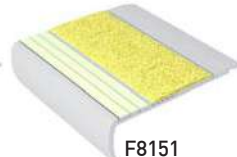

FA8151
YELLOW NON-SLIP

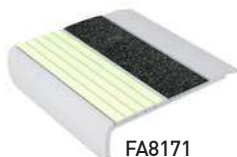
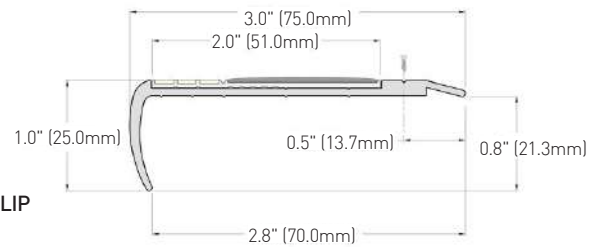

FA8171
BLACK NON-SLIP



FA8161
GREY NON-SLIP

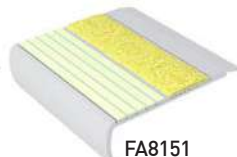

FA8151
YELLOW NON-SLIP

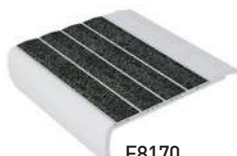
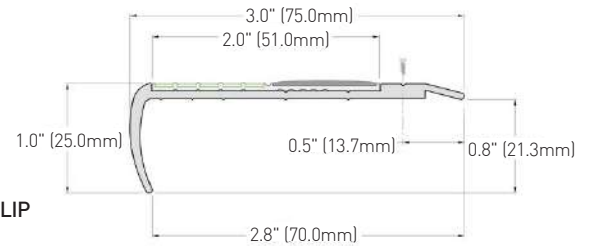

F8170
BLACK NON-SLIP



F8160
GREY NON-SLIP

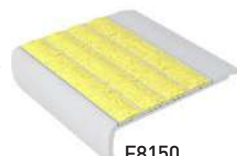

F8150
YELLOW NON-SLIP

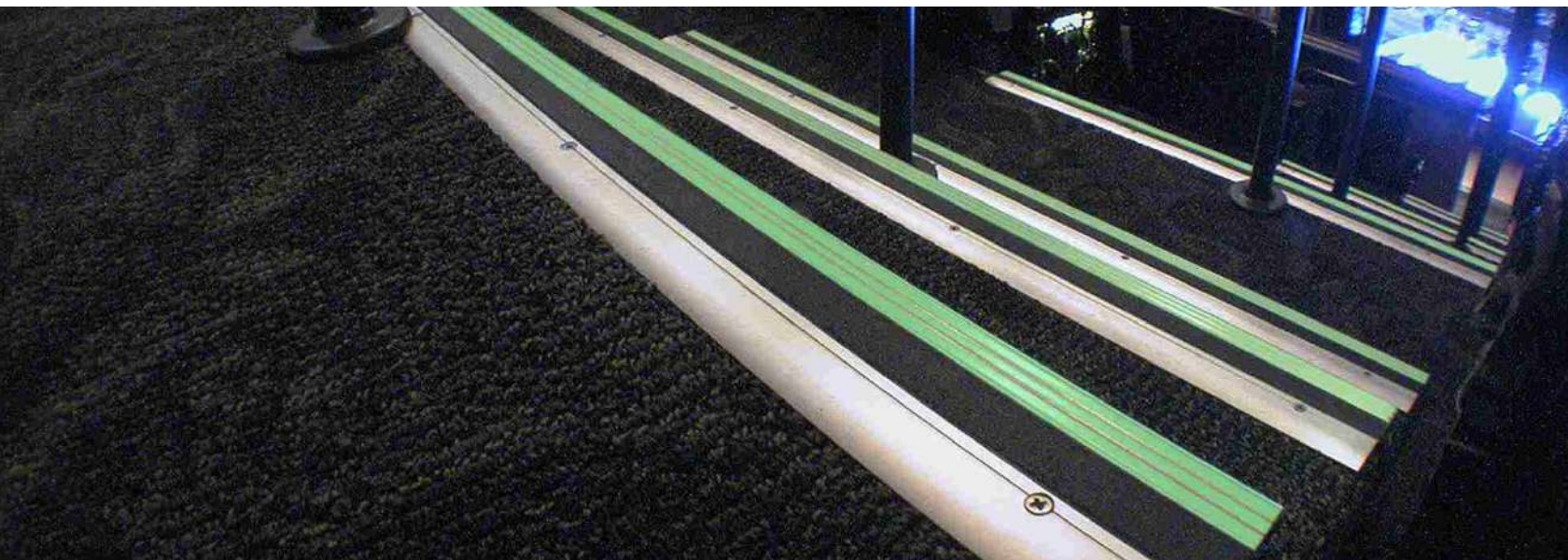
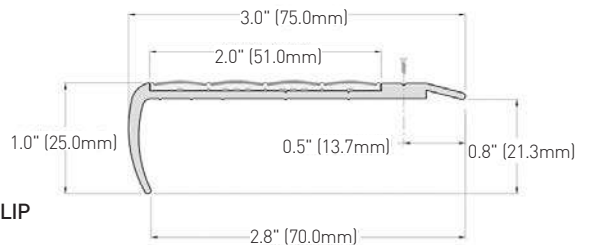

RF Series Flat Stair Nosings

Clear anodized aluminum standard (Type 11, Class 1), black, bronze and custom colour anodizing available as a special order.



RF5171
BLACK NON-SLIP

RF5161
GREY NON-SLIP

RF5151
YELLOW NON-SLIP

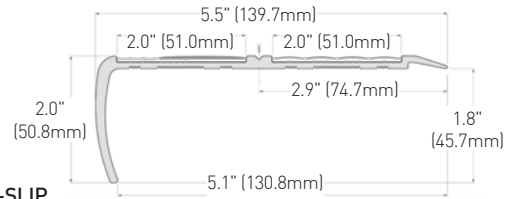

RFA5171
BLACK NON-SLIP

RFA5161
GREY NON-SLIP

RFA5151
YELLOW NON-SLIP

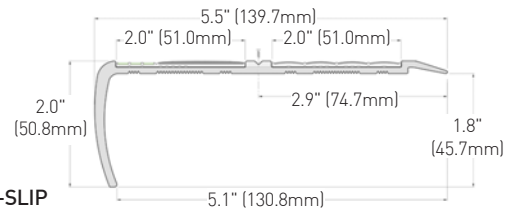

RF5170
BLACK NON-SLIP

RF5160
GREY NON-SLIP

RF5150
YELLOW NON-SLIP

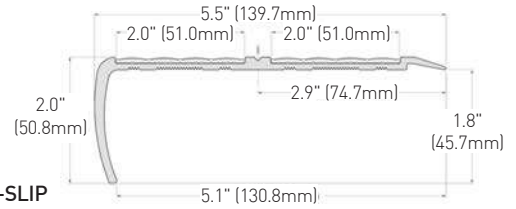

RF7171
BLACK NON-SLIP

RF7161
GREY NON-SLIP

RF7151
YELLOW NON-SLIP

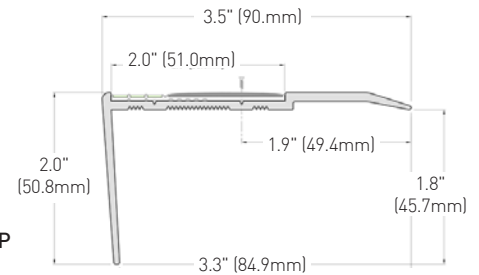

RFA7171
BLACK NON-SLIP

RFA7161
GREY NON-SLIP

RFA7151
YELLOW NON-SLIP

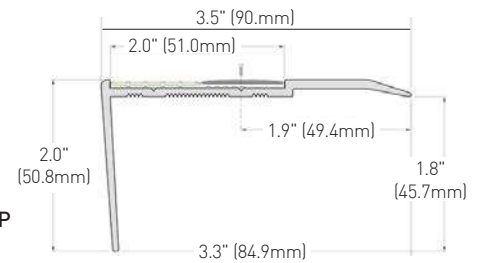

RF7170
BLACK NON-SLIP

RF7160
GREY NON-SLIP

RF7150
YELLOW NON-SLIP

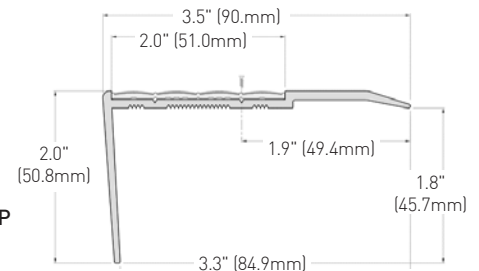

C Series Carpet Stair Nosings

Clear anodized aluminum standard (Type 11, Class 1), black, bronze and custom colour anodizing available as a special order.

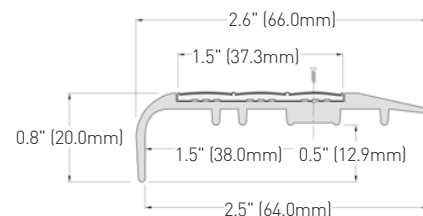
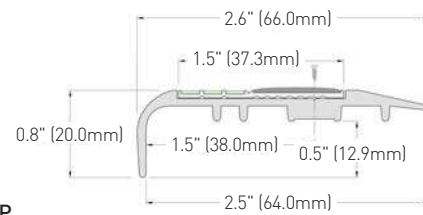
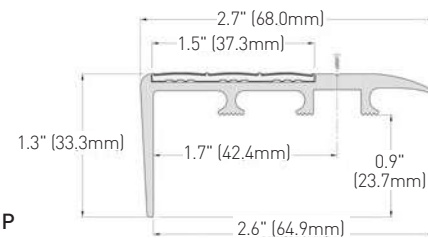
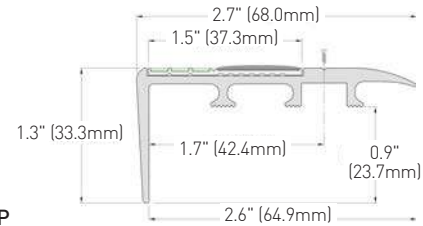

RC Series Carpet Stair Nosings

Clear anodized aluminum standard (Type 11, Class 1), black, bronze and custom colour anodizing available as a special order.

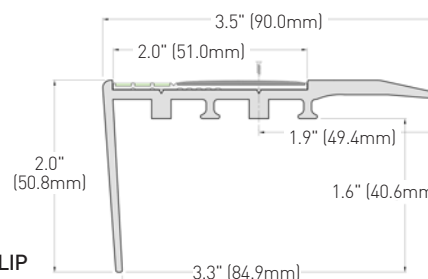

RC Series Carpet Stair Nosings

Clear anodized aluminum standard (Type 11, Class 1), black, bronze and custom colour anodizing available as a special order. Continued.

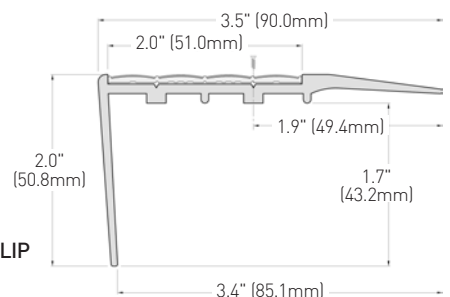
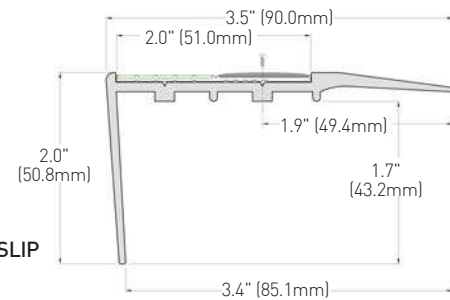
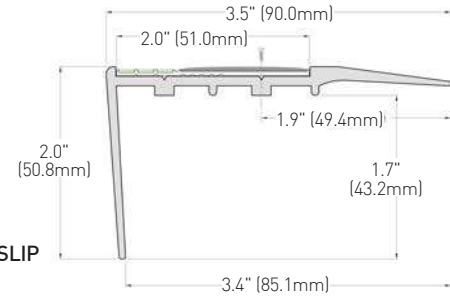
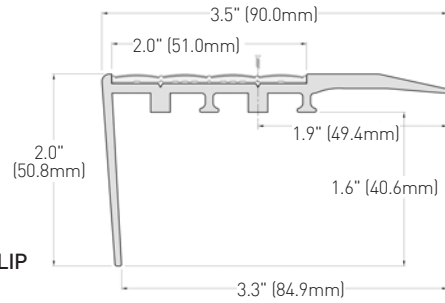
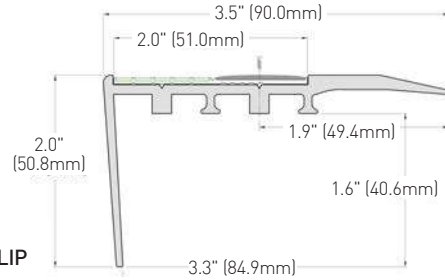

S Series Cast-in-Place Inserts

Clear anodized aluminum standard (Type 11, Class 1), black, bronze and custom colour anodizing available as a special order.

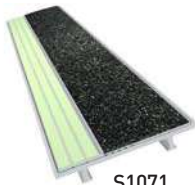

S1071
BLACK NON-SLIP



S1061
GREY NON-SLIP

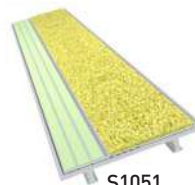

S1051
YELLOW NON-SLIP

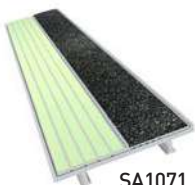
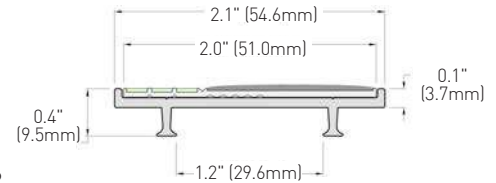

SA1071
BLACK NON-SLIP



SA1061
GREY NON-SLIP

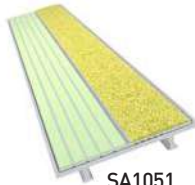

SA1051
YELLOW NON-SLIP

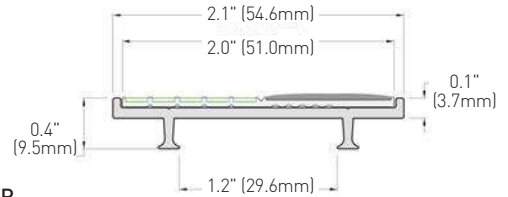

S1070
BLACK NON-SLIP



S1060
GREY NON-SLIP



S1050
YELLOW NON-SLIP

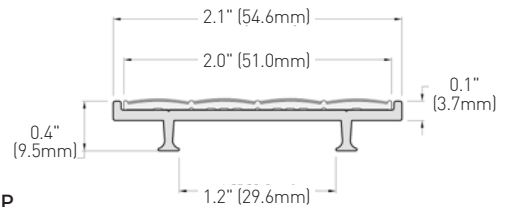

S2071
BLACK NON-SLIP



S2061
GREY NON-SLIP

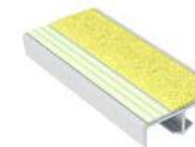

S2051
YELLOW NON-SLIP

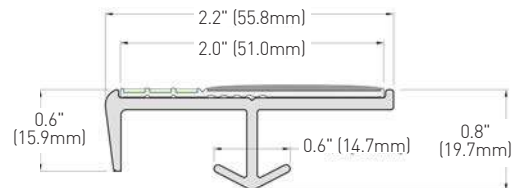

SA2071
BLACK NON-SLIP



SA2061
GREY NON-SLIP



SA2051
YELLOW NON-SLIP

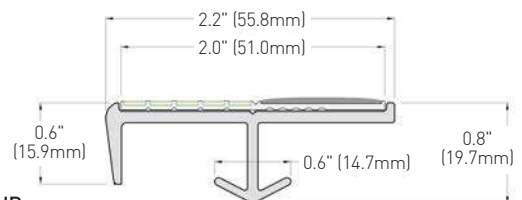

S2070
BLACK NON-SLIP



S2060
GREY NON-SLIP



S2050
YELLOW NON-SLIP

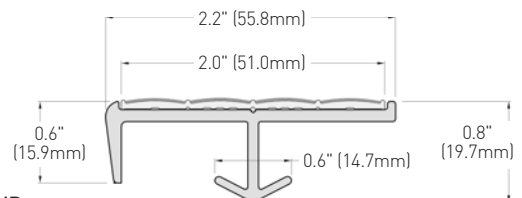

S Series Cast-in-Place Inserts

Clear anodized aluminum standard (Type 11, Class 1), black, bronze and custom colour anodizing available as a special order. Continued.



S3071
BLACK NON-SLIP



S3061
GREY NON-SLIP



S3051
YELLOW NON-SLIP

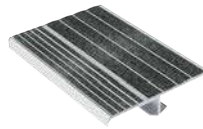
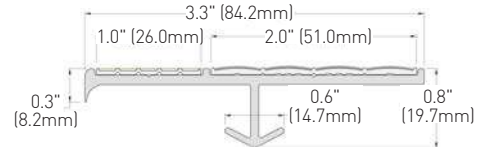

S3070
BLACK NON-SLIP

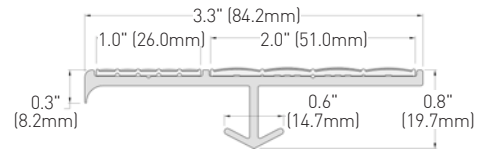

S4071
BLACK NON-SLIP



S4061
GREY NON-SLIP



S4051
YELLOW NON-SLIP

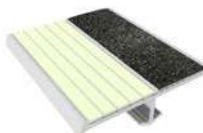
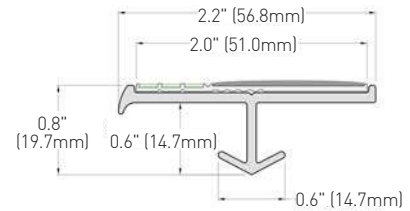

SA4071
BLACK NON-SLIP



SA4061
GREY NON-SLIP

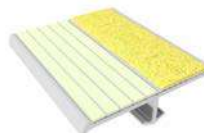

SA4051
YELLOW NON-SLIP

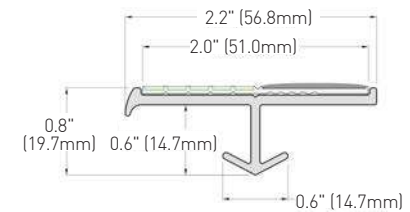

S4070
BLACK NON-SLIP



S4060
GREY NON-SLIP

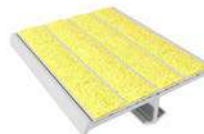

S4050
YELLOW NON-SLIP

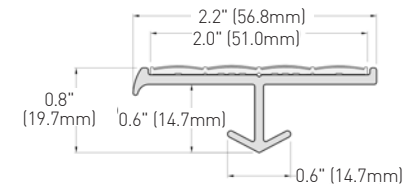

M Series Tile Nosings

Clear anodized aluminum standard (Type 11, Class 1), black, bronze and custom colour anodizing available as a special order.



M4171.10
BLACK NON-SLIP



M4161.10
GREY NON-SLIP



M4151.10
YELLOW NON-SLIP

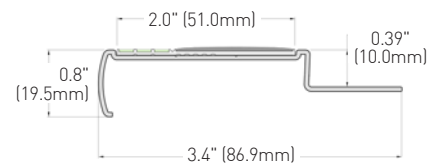

MA4171.10
BLACK NON-SLIP



MA4161.10
GREY NON-SLIP



MA4151.10
YELLOW NON-SLIP

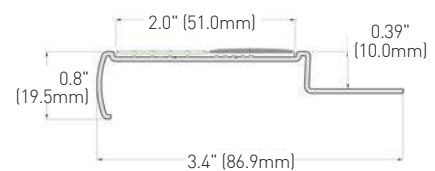

M4170.10
BLACK NON-SLIP



M4160.10
GREY NON-SLIP



M4150.10
YELLOW NON-SLIP

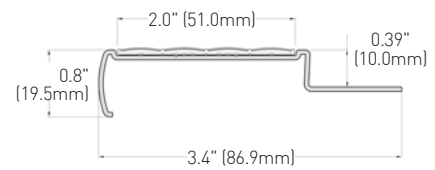

M4171.125
BLACK NON-SLIP



M4161.125
GREY NON-SLIP



M4151.125
YELLOW NON-SLIP

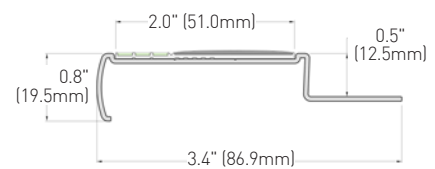

MA4171.125
BLACK NON-SLIP



MA4161.125
GREY NON-SLIP



MA4151.125
YELLOW NON-SLIP

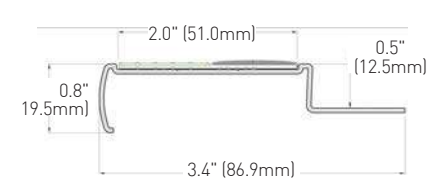

M4170.125
BLACK NON-SLIP



M4160.125
GREY NON-SLIP



M4150.125
YELLOW NON-SLIP

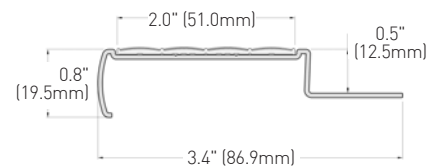

Resilient Flooring Stair Nosings

Clear anodized aluminum standard (Type 11, Class 1), black, bronze and custom colour anodizing available as a special order.



RF7B171
BLACK NON-SLIP



RF7B161
GREY NON-SLIP



RF7B151
YELLOW NON-SLIP

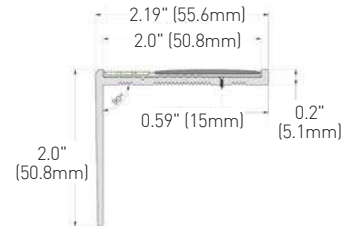

RFA7B171
BLACK NON-SLIP



RFA7B161
GREY NON-SLIP



RFA7B151
YELLOW NON-SLIP

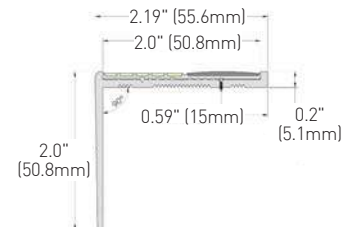

RF7B170
BLACK NON-SLIP



RF7B160
GREY NON-SLIP

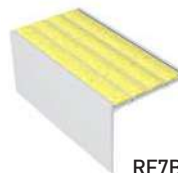

RF7B150
YELLOW NON-SLIP

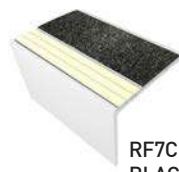
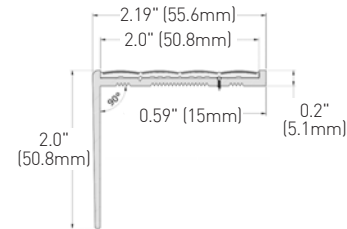

RF7C171
BLACK NON-SLIP



RF7C161
GREY NON-SLIP



RF7C151
YELLOW NON-SLIP

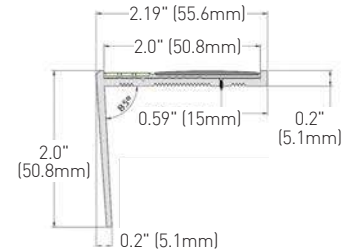

RFA7C171
BLACK NON-SLIP



RFA7C161
GREY NON-SLIP



RFA7C151
YELLOW NON-SLIP

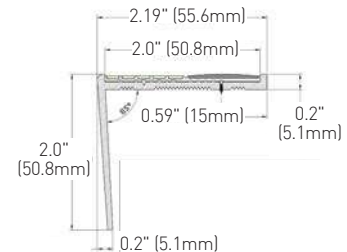

RF7C170
BLACK NON-SLIP



RF7C160
GREY NON-SLIP

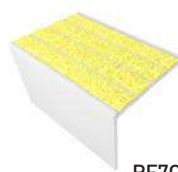

RF7C150
YELLOW NON-SLIP

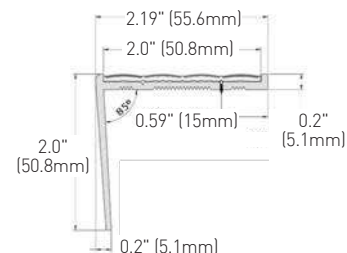

Pathmarking Signs

Pathmarking Signs



EXIT TO THE RIGHT

RA02012
8" x 4.6"
(203mm x 116.84mm)



EXIT TO THE LEFT

RB02012
8" x 4.6"
(203mm x 116.84mm)



EXIT DOWN AND TO THE RIGHT

RC02012
8" x 4.6"
(203mm x 116.84mm)



EXIT DOWN AND TO THE LEFT

RD02012
8" x 4.6"
(203mm x 116.84mm)



EXIT UP AND TO THE RIGHT

RE02012
8" x 4.6"
(203mm x 116.84mm)



EXIT TO THE LEFT

RF02012
8" x 4.6"
(203mm x 116.84mm)



EXIT STRAIGHT AHEAD AND UP

RG02012
8" x 4.6"
(203mm x 116.84mm)



EXIT STRAIGHT AHEAD AND DOWN

RH02012
8" x 4.6"
(203mm x 116.84mm)

Wall Mounted Pathmarking Door Signs



EXIT TO THE RIGHT

RAE2122
8.4" x 8.89"
(213.36mm x 226mm)



EXIT TO THE LEFT

RBE2122
8.4" x 8.89"
(213.36mm x 226mm)



FINAL EXIT TO THE RIGHT

RAF2128
8.4" x 11.1"
(213.36mm x 282mm)



FINAL EXIT TO THE LEFT

RBF2128
8.4" x 11.1"
(213.36mm x 282mm)



EXIT TO THE "CUSTOM WORDING"

RBY4219
16.4" x 7.4"
(416.56mm x 188mm)



Pathmarking Signs

Obstruction Markings Products



OBSTRUCTION STRIP

OB20025
1" x 39"



OBSTRUCTION STRIP

G250R-OB
1" x 39"



OBSTRUCTION STRIP - CURVED

G250R-OB-C (Curved)
1" x 39"

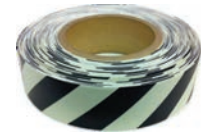

OBSTRUCTION TAPE

G300F-OB
1" x 30 Ft Roll

Door Marking Products



RUNNING MAN WITH EXIT

ROE3312
13" x 4.6"
(330mm x 116.84mm)



NOT AN EXIT (TEXT ONLY)

00N1854
7" x 2.1"
(177.8mm x 53.34mm)



DOOR HANDLE INDICATOR

DHM1010
4" x 4"
(100mm x 100mm)



PANIC BAR INDICATOR

DHM03YY
1" x Custom Cut

Floor Identification Markers

Ecoglo photoluminescent floor identification is an important part of egress safety due to the critical information that they provide. Ecoglo floor identification markers provide essential information in case of emergency, visible even after sudden loss of electrical power and lighting.

- Simple "peel and stick" installation with reliable 3M double sided tape pre-applied to signs
- Safe to use - non-toxic and non-radioactive
- Sizes can be altered to accommodate the letter/numbers/circles required
- Circle size is 5 1/2" or 7 1/2"









Size 5" - 8" W x 5" - 8" H
1-4 characters









Size 4" - 7" W x 4" H
1-3 characters, no circle

Guidance Strips, Door Frame Rails and Flat Aluminum Stair Nosings

Egress Signage Products

						
EXIT SIGN	EMERGENCY EXIT SIGN	ARROW	RUNNING MAN	FIRE ALARM	FIRE EXTINGUISHER	FIRE HOSE
EX2010 7.9" x 3.9" (200mm x 100mm)	EE2010 7.9" x 3.9" (200mm x 100mm)	AR1010H or AR1010D 3.9" x 3.9" (100mm x 100mm)	RM1010 3.9" x 3.9" (100mm x 100mm)	FA1010 3.9" x 3.9" (100mm x 100mm)	FE1010 3.9" x 3.9" (100mm x 100mm)	FH1010 3.9" x 3.9" (100mm x 100mm)

Aisle Markers Products

					
LARGE RECTANGLE	SMALL RECTANGLE	SQUARE	LONG RECTANGLE	60MM ROUND AISLE MARKER	68MM ROUND AISLE MARKER
RE65/45 2.6" x 1.8" (65mm x 45mm)	RE45/32.5 1.8" x 1.3" (45mm x 32.5mm)	SQ88/88 3.6" x 3.6" (88mm x 88mm)	RE38/161 1.6" x 6" (38mm x 161mm)	DS60 2.4" (60mm Round)	DS68 2.7" (68mm Round)

Seat Numbers Products

				
SQUARE WITH ROUNDED CORNERS	40MM ROUND SEAT NUMBER	ELIPSE	OBROUND LARGE	OBROUND SMALL
SQ31.9r 1.3" x 1.3" (31.9mm x 31.9mm)	DS40 1.6" (40mm Round)	EL 18.7/56.7 0.7" x 2.2" (18.7mm x 56.7mm)	OR16/44.6 0.6" x 1.8" (15.2mm x 44.6mm)	OR14.7/27.2 0.6" x 1.1" (15.2mm x 27.2mm)

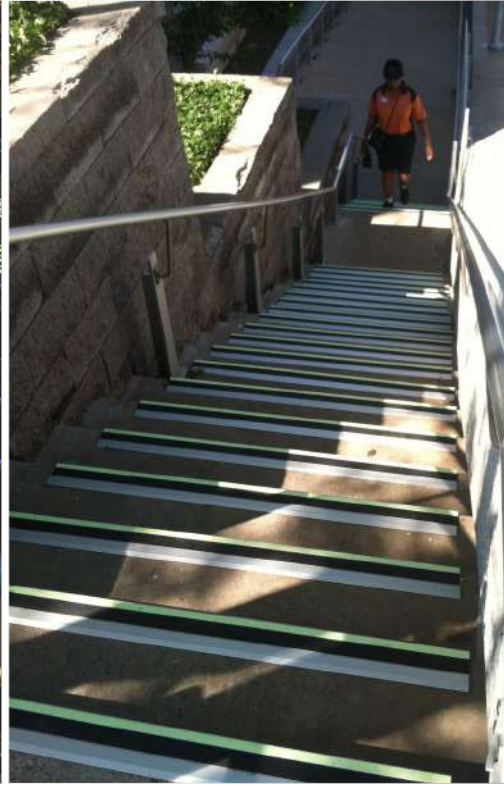

 ecoglo®

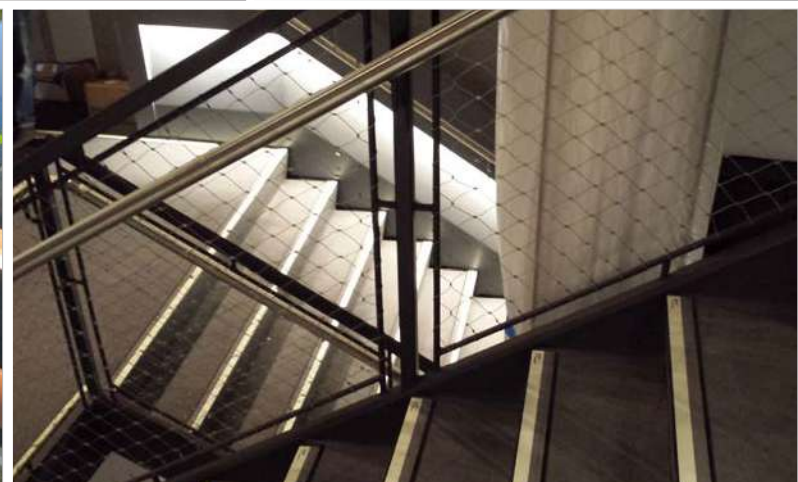
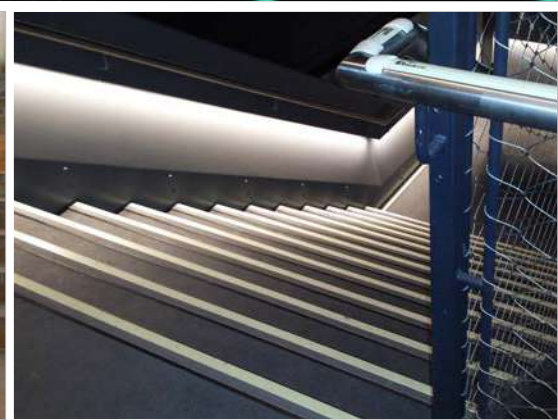
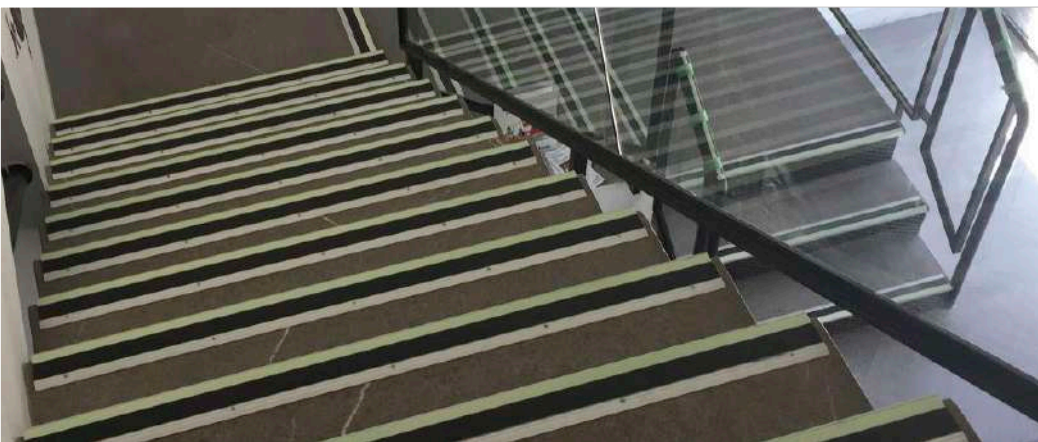

Standard Series Photoluminescent Exit Sign System

ULC S572 Standard Series

- LEED points qualified for energy conservation and sustainability
ULC S572 listed for Photoluminescent and Self-Luminous Exit Signs
- 50/75 foot visibility rating
- No electricity or batteries required
- Indoor installation, only
- Standard twenty-five year warranty
- Requires exposure to at least 54 lux (5 foot-candles) of fluorescent, metal halide, mercury vapor, or other 4000K light illumination for a minimum of 60 minutes to become fully operational
- Non-toxic and non-radioactive
- ULC certified/listing no. E344049/4RG2



Ceiling Mounting Style



Flag Mounting Style



Flag Mounting Style



Ceiling Mounting Style

Model Selection

RM - (Directional) (Rating) (Mount)

Sides and Direction	
1-Sided	
RD	Right-facing running man with down arrow
LA	Left-facing running man with arrow
RA	Right-facing running man with arrow
RU	Right-facing running man with up arrow
2-Sided	
SA	Single direction with arrows
DA	Bi-directional with arrows*
* Special order only, subject to availability. Standard mounting kits not compatible with bi-directional signs.	

Frame and Mounting Kit	
(blank):	No frame
CA:	Clear anodized aluminum frame and mounting kit

Visibility (Feet) Size: Framed / Unframed	
50 Feet:	16.2" x 9.5" (411mm x 241mm) / 15.5" x 8.8" (393mm x 223mm)
75 Feet:	19.6" x 11.6" (498mm x 296mm) / 18.9" x 10.9" (480mm x 278mm)
50 Bi-Directional:	22.9" x 9.5" (582mm x 241mm) / 22.2" x 8.8" (564mm x 223mm)
75 Bi-Directional:	27.4" x 11.6" (695mm x 296mm) / 26.7" x 10.9" (677mm x 278mm)

Example 1: RM-RD50

1-Sided, Right-facing running man with down arrow, No frame

Example 2: RM-SA75-CA

2-Sided, Single direction with arrows, 75-Foot, Clear anodized aluminum frame and mounting kit



Architectural Series Photoluminescent Exit Sign System

Running Man Architectural | ULC S572 Standard Series

- LEED points qualified for energy conservation and sustainability ULC S572 listed for Photoluminescent and Self-Luminous Exit Signs
- 50/75 foot visibility rating
- No electricity or batteries required
- Indoor installation only
- Standard twenty-five year warranty
- Requires exposure to at least 54 lux (5 foot-candles) of fluorescent, metal halide, mercury vapor, or other 4000K light illumination for a minimum of 60 minutes to become fully operational
- Non-toxic and non-radioactive
- ULC certified /listing no. E344049/4RG2



Wall Mounting Style

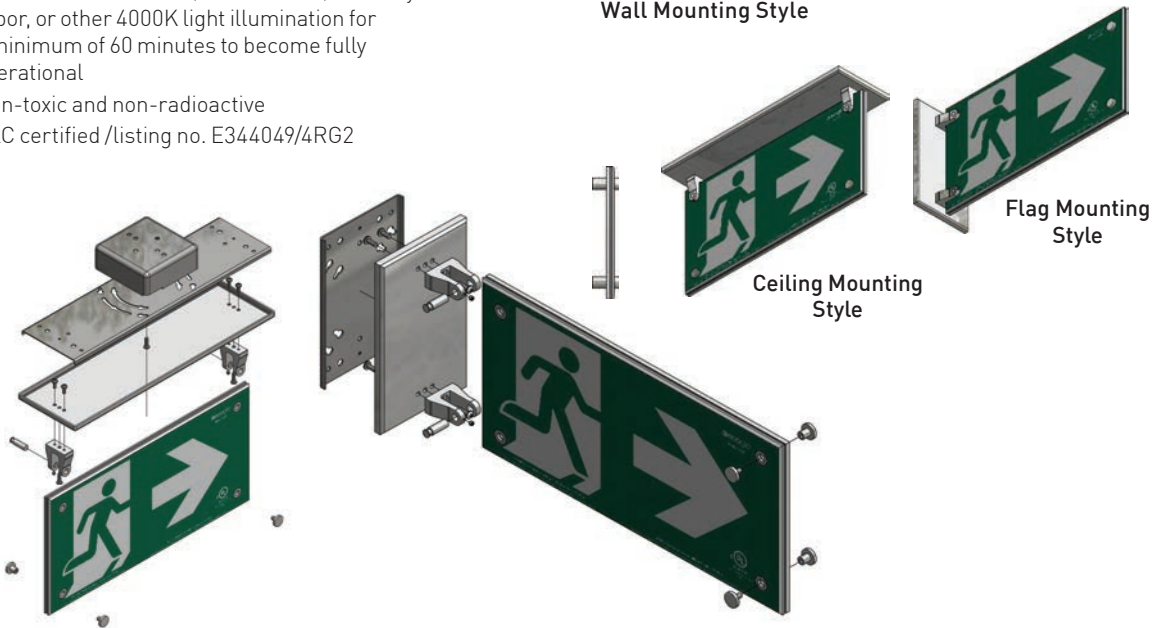

Flag Mounting Style

Ceiling Mounting Style

Model Selection

RMA - (Directional) (Rating) (Mount)

<p>Sides and Direction</p> <p>1-Sided</p> <p>RD Right-facing running man with down arrow</p> <p>LA Left-facing running man with arrow</p> <p>RA Right-facing running man with arrow</p> <p>RU Right facing running man with up arrow</p> <p>BA Running man with bi-directional arrows*</p> <p>2-Sided</p> <p>SA Single direction with arrows</p> <p>DA Bi-directional with arrows*</p> <p>* Special order only, subject to availability. Standard mounting kits not compatible with bi-directional signs.</p>	<p>Visibility (Feet) Size</p> <p>50 Feet: 15.1" x 7.6" (384mm x 193mm)</p> <p>75 Feet: 18.9" x 10.9" (480mm x 278mm)</p> <p>Mounting Kit WALL / CEILING / FLAG</p> <p>Example 1: RMA-SA50CEILING 2-Sided, Single direction with arrows, 50-Foot, Ceiling mounting kit</p> <p>Example 2: RMA-LA75WALL 1-Sided, Left-facing running man with arrow, 75-Foot, Wall mounting kit</p>
---	--

Hybrid Running Man Exit Sign

The RMH Series Hybrid Exit Sign is the no compromise solution for exit signage incorporating the safest backup technology and sophisticated design. Advanced manufacturing processes and elegant finish add a unique refined appearance to both the sign and the space in which it is installed.

- LED/Photoluminescent Exit Sign System
- No Batteries or Backup Power Required for Power Outages
- High Efficiency Low Power Consumption LED Luminance
- Certified for 120 Minute Operating Time at 50 or 75 Ft Visibility
- Universal Mount - Convenient Turn & Lock™ Mounting System for Quick and Versatile Installation
- Non-Toxic, Non-Radioactive Photoluminescent Technology
- Directional Labels Included
- Indoor Installation Only
- ULC S572 Tested and listed
- Ten year warranty



Wall Mounting Style

Part Numbers and Descriptions

RMH-0150	Single Sided Running Man, 50ft Rated
RMH-0250	Double Sided Running Man, 50ft Rated
RMH-0175	Single Sided Running Man, 75ft Rated
RMH-0275	Double Sided Running Man, 75ft Rated

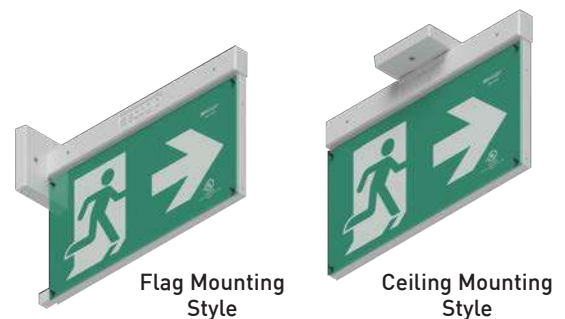

Flag Mounting Style

Ceiling Mounting Style

Universal Pictograms

Double sided signs include a pictogram with a left facing directional indicator and a pictogram with a right facing directional indicator.

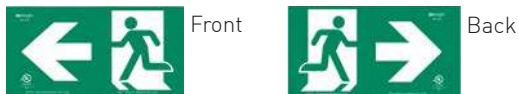

Single sided signs include one of each graphic as shown below:



Internal Specification

AC LED: standard 120/240 VAC input
 SELF-ILLUMINATED: Glow in the dark sealed plates to provide a minimum 120 minutes of emergency illumination. Performance Certified.

Electrical Specification

The Ecoglo® RMH series is configured with high-output LEDs, requiring 120/240 VAC input. All versions consume only 4.5W when powered. When power is not available, signs remain illuminated, requiring no power for 120 minutes.

Installed Projects



BBB Stadium
Winnipeg, Manitoba



Place Bell
Laval, Québec



Commerce Court
Toronto, Ontario



Toronto Transit Commission
Subway



University of Waterloo
Waterloo, Ontario



River Run Theatre
Guelph, Ontario



1700 Manitoba Street
Vancouver, British Columbia



Eighth Avenue Place
Calgary, Alberta



The Pentagon
Arlington County, Virginia



TD Centre
Toronto, Ontario



Jubilee Auditorium
Calgary, Alberta



438 University Avenue
Toronto, Ontario

Installed Projects



Hong Kong Convention Centre
Hong Kong



Confederation Centre of the Arts
Charlottetown, P.E.I.



Time Warner Centre
New York City, New York



Burj Khalifa
United Arab Emirates



Eaton Centre
Toronto, Ontario



Markham Theatre
Markham, Ontario



Bloor Street
Toronto, Ontario



Hart House
University of Toronto
Toronto, Ontario



Sasktel Centre
Saskatoon, Saskatchewan



Medicine Hat Family
Leisure Centre
Medicine Hat, Alberta

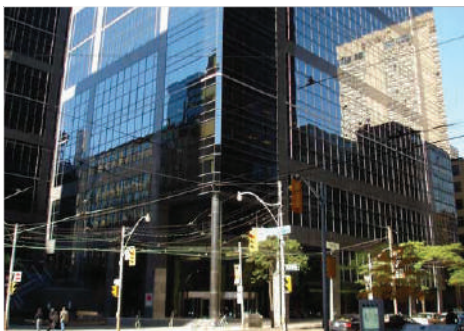

York Street
Toronto, Ontario



First Canadian Place
Toronto, Ontario



ENGINEERED PRODUCTS

The Power of Intelligent Design and
Precision Engineering™

Kinesik Engineered Products Incorporated
2213 North Sheridan Way Phone: 855.364.7763
Mississauga, Ontario L5K 1A3 Fax: 800.769.4463
www.kinesik.ca

Follow and Like us on Social



 **ecoglo**®
VISIBLY BETTER
info.ecoglo@kinesik.ca